

# The Navigator



The Newsletter of Alamo Squadron

*The San Antonio chapter of the International Plastic Modelers' Society  
A registered 501c-7*

**August 2019**

IPMS/USA Chapter of the Year: 1999 & 2005

IPMS/USA Regional Chapter of the Year: 2016

IPMS/USA Regional Newsletter of the Year 2017

## FOR A CHANGE OF PACE:



## HELP RESTORE A WARBIRD!

Lee Forbes Uses His Modeling Research  
To Help "White 108" Get Back to the Skies

### Inside This Issue:

- Kit of the Month
- Packing for the Nats
- Weekend with Andrea
- HAMS Show Report



# President's Letter

by Craig Gregory

IPMS# 49320

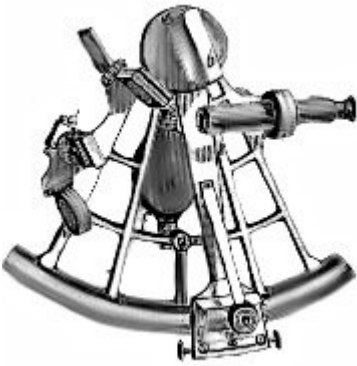

## President's Letter: August 2019

### *What kind of a modeler are you?*

I have given a lot of thought to how (in my mind) I struggle to put together a quality model build. I am envious of how immaculate other builder's projects are compared to my work and their productivity when I barely complete a few models a year. Why do I enjoy this hobby so much if I am always struggling?

I classify myself as an Engineering Modeler. I spend hours inspecting the model, surfing the Internet and planning my next build. Looking for available aftermarket options and watching other modeler's builds of the subject on YouTube are immensely enjoyable to me. Could this be contributing to the size of my stash? I enjoy the planning and acquiring materials for a build, but don't actually build?

Here is an example. You may remember the comparative builds that Len Pilhofer and I did of the original and new releases of the U.S.S Reliant. I went old school and build the original kit released by AMT/ERTL. Len built the "re-release" from Round 2 with aftermarket electronics, photo-etch and Aztec decals. Of course I also purchased a copy of the new kit, the photo-etch and decals for my future build.

But I went a different route for the electronics and this is why I think of myself as an engineering modeler. Instead of buying an aftermarket solution for the Reliant's lighting system, I design and build my own. I am a self-trained digital electronics engineer of sorts. During high school I built a computer in a shoebox and was an electronics major in college for 1.5 years. (I graduated as a computer scientist.)

I got onto eBay and ordered an Arduino, LEDs, resistors and a few other odds and ends. Within a few hours of receiving all the parts I had a flashing LED. But that didn't satisfy my engineering mind. I wanted LEDs flashing at different rate, LEDs that did not flash and the ability to control the LED's brightness. After about 3 weeks of work I had an Arduino programmable control that takes parameters for a data file to drive various "channels" of LEDs. Each channel has a programmable flashing pattern and brightness control. And I had to learn a new programming language in the process.

I haven't glued a single piece of plastic, but I have already had immense satisfaction on my future Reliant build. I have come to realize that envy of other modeler's achievements is normal and not to let them overrule the true enjoyment in the engineering aspect of our hobby that I enjoy so much.

*What kind of a modeler are you?*



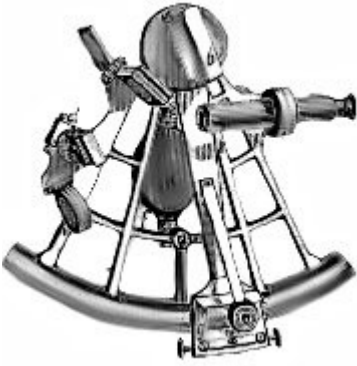

# Club Announcements

---

## Alamo Squadron Build Days

The most recent build day was held on the 1st of June at HobbyTown of San Antonio. The next Build Day is scheduled for Saturday, August 3rd. The intent of these build days is to move more of the social and building aspect of our meetings to a more conducive environment...and what better environment than a hobby store! There will be no set format but if a member wishes to see a first hand demo on a certain technique then this is the perfect opportunity to make it happen. We hope that many club members will take the opportunity to participate. And added bonus is that we will be able to recruit for Alamo Squadron while at this establishment answering any and all questions of passers-by.

## Monthly Contest Themes

August:	Open
September:	Open
October:	<b>Cold War</b>
Nov:	Open
Dec:	No Contest
<b>Jan:</b>	<b>Model of the Year</b>
<b>Feb:</b>	<b>Fabulous 50s</b>

## Monthly Programs:

**August: Swap Meet**  
September: Oil Washes and Filtering – Len Pilhofer  
October: Scribing Panel Lines – Rob Booth  
November: Working with LEDs – Len Pilhofer  
December: White Elephant Gift Exchange  
January: Basic Figure Painting – Henry Nunez  
February: What Judges Look For – Rob Booth  
March: Aircraft Rigging – Dick Montgomery  
April: Hydrodrp Technique—Paul Blackmon

## Navigator Articles!

Alamo Squadron's "The Navigator" is quickly becoming recognized across all of IPMS/USA as a high quality local chapter newsletter. Our success is entirely due to the tireless efforts of all of our members who contribute to its contents. In a few short years we have reached our goal of creating a newsletter that captures the learning spirit of our club and helps foster a learning environment. The contents of The Navigator undoubtedly help all who read it improve their own modeling. The club executive board encourages all members to contribute their work to the Navigator. This can be in the form of a feature article documenting a build and all the steps that went into it or it can be a technique demonstration. Or perhaps a review of a recently acquired kit or the review of a new tool that helps the modeler to the finish line. Members can also document one of the many shows attended by our members through the year. The ideas really are plentiful. If you have anything you wish to contribute please send your articles to Len Pilhofer at [pilhofer@hotmail.com](mailto:pilhofer@hotmail.com)

## IPMS National Convention

With just over a week away the biggest IPMS/USA show of the year is right around the corner: The National Convention, aka, "The Nats". This years show is going to be held in Chattanooga, TN from August 7th through the 10th. Many Alamo Squadron members will be attending. Our chapter is also sponsoring the Unmanned Aircraft Vehicle category of the National Contest for 2019. If you have the slightest interest in attending the Alamo Squadron E-Board encourages you to do so, it is an experience unlike any other in the scale modeling world.

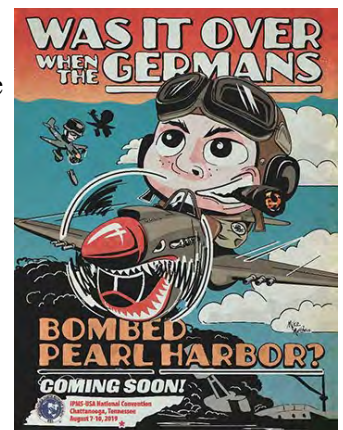



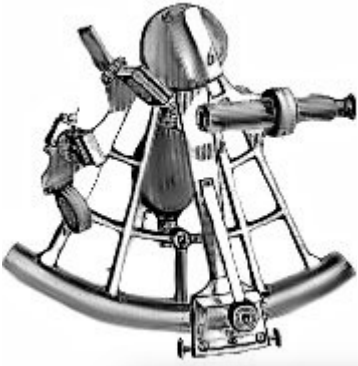

# Club Announcements

## July Monthly Contest Shades of Gray

First Place: 1967 Shelby Mustang GT 500

By: Keith Rule



Second Place: F-16XL

By: Rob Booth



Third Place: Confederate  
Infantry Officer

By: Henry Nunez

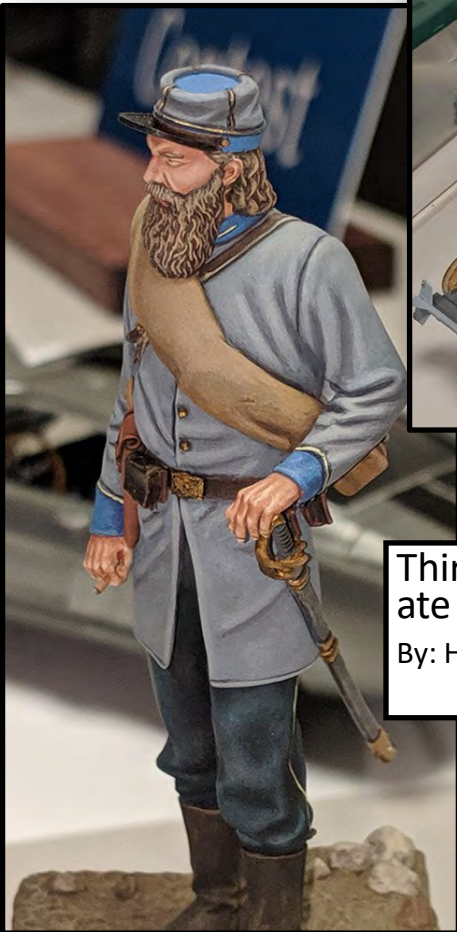

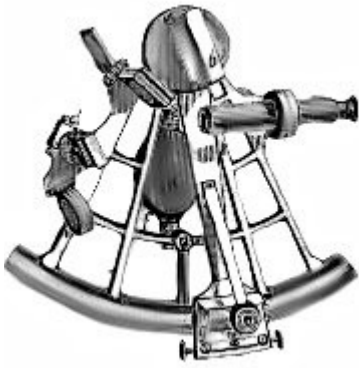

# Kit-of-the-Month

## 1965 Ford F-100 Service Truck

Presented by: Herb Scranton III  
IPMS# 48314

**H**ello again fellow modelers, Herb here with a new Kit of the Month, as most of you know I'm a fan of Ford trucks. Moebius with Model King have just release their next truck, a 1965 Ford F-100 Service Truck. It is a skill level 3 model and cost \$38.00 at Hill Country Hobby. I grew up around a lot of this type of vehicles. This is a follow on to their 1966 F-100 and it's a beauty.

This is a typical Moebius product, absolutely well done. In the box the kit consists of a beautifully rendered cab with very little mold lines that will be easy to clean up. 14 sprues of light tan parts, 2 sprues of chrome parts, and a sprue of clear and red transparent parts and a bag with 5 tires. Also included is a sheet of nicely done decals and a full color instruction manual. I could not find any flash and it looks like most of the pin marks will be hidden. The clear parts are well done and distortion free. The Chrome parts are in two bags, one bag is parts for a 1965 Ford truck and the second bag is generic parts of a Ford pickup. There are 3 sets of mirrors, 2 sets of valve covers, and a second set of hubcaps with 2 hubcaps with holes in the center. I also found two types of tailgates on the tan parts trees. This seems to indicate that Moebius is going to introduce a style-side and a 4X4 truck in the future. The tires are well molded in soft vinyl with good tread pattern but no sidewall detail. The decals have markings for a construction company, a welding service and various trades, also included are cab, engine, interior, license plates, and instrument decals.

Bravo Model King and Moebius for another great model, this is a subject a lot of truck modelers have been looking for, a light commercial vehicle with lots of possibilities. If you are interested in light trucks or just something a little different I highly recommend this kit.

Brand:	Moebius Models
Title:	1965 Ford F-100 Service Truck
Number:	1235
Scale:	1:25
Released:	2019   Initial release - new tool
Type:	Full kit

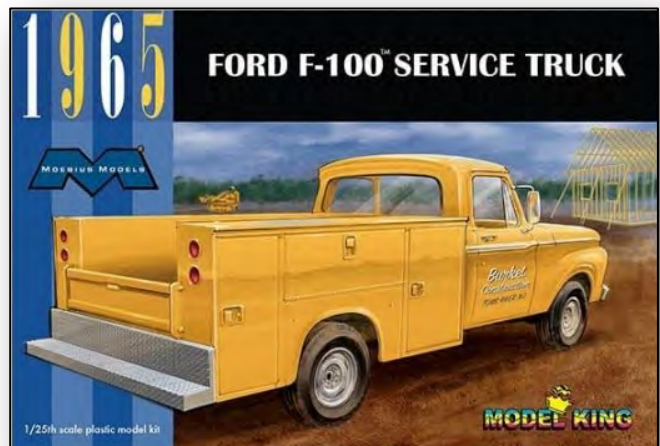



# Cover Story

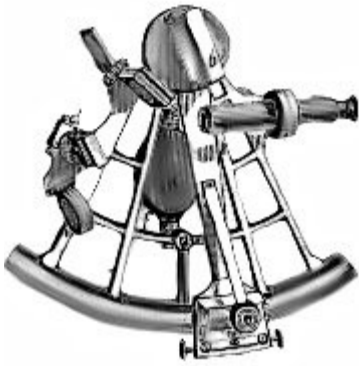

## For a Change of Pace, Help Restore a Warbird!

By Lee Forbes, IPMS# 2297



**W**henever you hear or read about the original American Volunteer Group (AVG), better known as the “Flying Tigers,” that flew against Japanese ground and air forces in Burma and China before the United States entered WWII, two names quickly come to mind: General Claire Chennault and David Lee “Tex” Hill. Chennault was the AVG Commander and “Tex” Hill was the Squadron Leader of the 2<sup>nd</sup> Squadron. While there were two other Squadrons in the AVG, the 1<sup>st</sup> Squadron led by Robert Neale, and the 3<sup>rd</sup> Squadron, Led by Arvid Olson, it seems that “Tex” Hill, for whatever reason, garnered most of the publicity about the Group. As some of you may know I had the distinct honor and pleasure of knowing “Tex” Hill personally from 2000 until his death in 2007 as his volunteer “ghost writer” and administrative aide who answered his considerable worldwide fan mail for him and assisted him in handling numerous special projects. One of those projects involved the restoration of a WWII Curtiss, P-40E “Kittyhawk” Lend Lease fighter plane recovered from a crash site near Murmansk, Russia in early 2000. That’s how I got into the business of being a “Pro Bono” aircraft



camo and markings consultant to several owners of flyable Warbirds. In this particular case Mr. Jerry Yagen, owner of an extensive flyable warbirds collection, located near Virginia Beach, VA, contacted “Tex” Hill a few months after I started helping him and mentioned that he was going to restore a P-40E that he had recovered in Russia and asked “Tex” if he had flown any of the replacement P-40Es that the AVG had received before they disbanded July 4, 1942. “Tex” responded yes, and proceeded to tell him the story of how he had led a flight of four of the new airplanes to bomb a Japanese Army Division advancing on the Burma Road toward Southern China at the Salween River Gorge on May 7, 1942. Mr. Yegan told “Tex” he’d be honored to paint his P-40E in the camo and markings of the airplane that “Tex” flew during that famous bombing raid, that probably kept China in the War, when his restoration was completed. “Tex” told him he’d be honored likewise, and asked me, “To work with Mr. Yagen’s people to help them out in any way I could.” Even though I knew a lot about the Flying Tigers, and the P-40Bs the AVG was equipped with, I had to conduct some additional research to learn about the AVG’s replacement P-40Es.

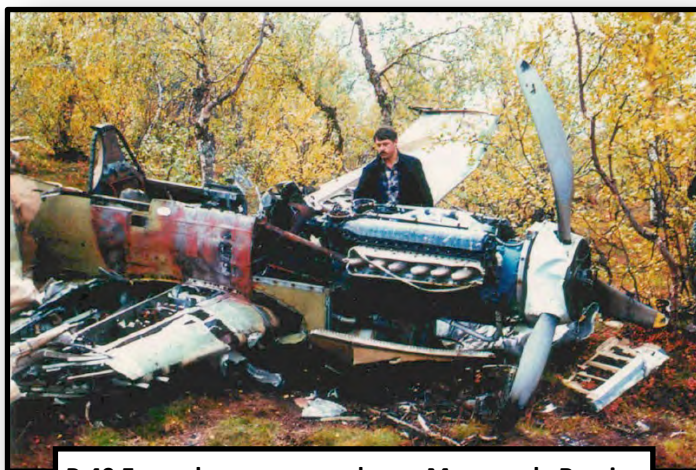

P-40 E wreckage recovered near Murmansk, Russia.

In March, 1942, the AVG started to receive the new P-40Es from USAAF stores in West Africa when a half-dozen 3<sup>rd</sup> Squadron pilots volunteered to ferry them back to China. Of course the first P-40Es were assigned to the 3<sup>rd</sup> Squadron. They were left in USAAF markings during the flight and only modified with

# Cover Story

## Help Restore a Warbird!



Jerry Yagen posing with "Tex" Hill next to AVG P-40E "White 108" at 2004 Flying Tiger Association Reunion

AVG markings after arrival in China. The full series of replacement aircraft when received, were to be numbered "101" through "134." They were all painted Olive Drab and Neutral Gray, and had "U.S. ARMY" painted under their wings in Insignia Blue, not Black, which is often depicted. These markings were retained. The fuselage USAAF insignias were painted out in Dark Green and not replaced. There were no serial numbers of any kind painted on the vertical fin. The other four wing insignias were all replaced with new adhesive decal Chinese insignia. The Red fuselage band of the 3<sup>rd</sup> Squadron and the new nose shape of the "Sharks Mouth" White teeth and Red tongue were also added. Other markings included a Walt Disney-designed Flying Tiger decal being added just aft of the cockpit and the new slightly smaller White ID Numbers were placed mid-way on the Dark Green painted over fuselage insignia and parallel with the ground. Some P-40Es had the distinctive 3<sup>rd</sup> Squadron, Tricolor Red, White and Blue dust covers added to their wheels, but this was not uniform in all cases. The specific aircraft flown by "Tex" Hill when he led

the bombing raid at the Salween River Gorge on May 7, 1942 was one of the newly arrived 3<sup>rd</sup> Squadron airplanes numbered "White 108" as were those aircraft numbered, "White 102", "White 104" and "White 106," flown by his three Squadron Mates. All of the "bombers," including "Tex," were flown by experienced former U.S. Navy Dive Bomber pilots. The reason the replacement P-40Es were so welcome, was they could carry bombs or fuel tanks on their centerline and were equipped with six .50 caliber machine guns in each wing. Whereas, the P-40Bs were only equipped with two .50 caliber machine guns in the nose and four .30 caliber machine guns in the wings, and couldn't carry bombs of any type or fuel tanks on their centerline.

One of the first things I did before the restoration actually began in 2000, was to prepare an extensive monograph describing the details of the May 7, 1942, Salween River Gorge Bombing Raid, based on "Tex's" amazing recollection of the event. This was shared



Cockpit of AVG P-40E "White 108"  
Note: Interior Color is RAF Gray-Green



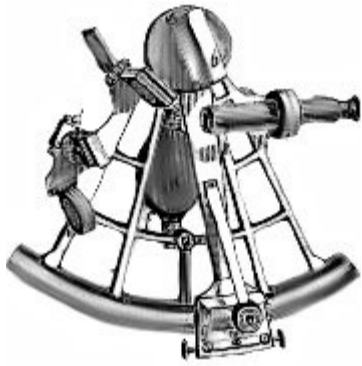

# Cover Story

## Help Restore a Warbird!

with all concerned with the restoration project, including photos of the airplane flown by “Tex” on that mission. This monograph was later re-formatted and appeared in the October 2005, issue of Flight Journal, as a Tailview piece by David Lee “Tex” Hill titled, “Shooting Fish in a Barrel.”

The Point of Contact, in Mr. Yagen’s organization, that I worked with throughout the two year restoration project was his Director of Aviation, Mr. Chris Vitiphil. The actual restoration work was done by AvSpec Ltd., Owned by Mr. Warren Denholm, at Ardmore Airfield, Auckland, New Zealand. Most of my contact with everyone was via e-mail, and I received almost weekly progress reports consisting of color photos of the airplane as it progressed from a “pile of corroded parts” to a flyable airplane when finished. Naturally, “Tex” was delighted to see his “airplane” taking shape. When the time came to paint the airplane, Mr. Vitiphil, knowing that I was an aircraft model builder, asked me if I could recommend any paint sources to be used to duplicate the USAAF Olive Drab and Neutral Gray in use in the 1942 time frame. I told him of the Modelmaster Enamel pre-mixed paints that I used in my hobby. He said, “That sounds great.” In a few days, he mailed me four aircraft aluminum 4” X “4” squares already primed in zinc chromate to on which to air brush the Modelmaster Olive Drab and Neutral Gray paints. And those were the colors Mr. Denholm matched to paint Mr. Yagen’s newest addition to his flyable collection.

Mr. Yagen’s P-40E airplane was debuted at the 2002 Warbirds Over Wanaka International Air Show at Wanaka Airport, New Zealand in 2002 and he was in attendance. After the Air Show, the airplane was disassembled and shipped to Virginia Beach, VA where it was re-assembled and test flown before P-40E “White 108” became the newest addition to his grow-

ing collection of flyable warbirds. “Tex” Hill saw “his” airplane for the first time when Mr. Yagen flew it to the 2004 Flying Tigers Association Reunion held at Kermit Week’s Fantasy of Flight location near Kissimmee, FL. While the airplane was at the Reunion, “Tex” Hill signed his distinctive signature on the inside of the radio access door.

I saw “Tex’s” signature for the first time when I attended an IPMS/USA sponsored event held at Mr. Yagen’s Military Aviation Museum during the 2008 IPMS National Convention, in Virginia Beach, VA. While I had never personally met Mr. Yagen during the restoration of his P-40E “White 108”, I had the occasion to meet him that night, and he told me how much he and his team appreciated my assistance during the project. He later invited me to go flying with him for about 20 minutes that evening in a Navy “Yellow Peril” Biplane Stearman...of course I couldn’t turn him down. That certainly was the highlight of that particular Virginia Beach Convention for me. My next involvement in the restoration of a flyable warbird, was an F-86 F (AKA Canadair Mk 6), in the markings of the late Korean War Double Fighter Ace, Colonel Ralph Parr, that is now part of the Lewis Aviation Legends flyable collection. But as they say, “That’s another story!” -LF



Lee’s “White 108” in 1/72, completed with the help of his granddaughter



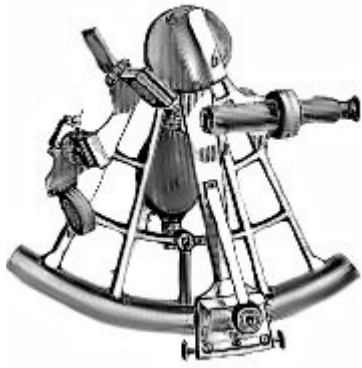

# Feature Story

## A Weekend with Andrea

Story and photos by Eric Syverson IPMS# 50324



No, Andrea isn't my girlfriend. She's not my wife. Or mistress. Who has time for girls when you have a hobby like ours? Andrea is more like a Mrs. Butterworths—what Mrs. Butterworths is to pancakes. Or Aunt Jemima. Consider Betty Crocker. What would cooking be without Betty? So Andrea is in that class of fine ladies. If you're painting miniatures you know what I mean. Andrea just makes it better.

**[Disclaimer: The writer of this article likes to joke and cannot be held responsible for any problems resulting from a reader's failure to know the difference. Always have time for your wife. Unless it's the night before a show.]**

So far I'm just a plane builder, but I've always wanted to learn how to paint miniature figures to add visual scale to an aircraft build. Sure, you and I understand scale. But when there's a figure next to a build you really see scale. You comprehend the size of the main subject immediately. If done well a figure can also add a bit of story. It can give the viewer a chance to imagine something beyond the build itself. It can convey a mood. Those were my reasons to learn how to paint miniatures. Of course you could say I just wanted to put a little dude next to a little plane and have it look real. And that is also true.

One day I was reading my weekly e-mailer from King's Hobby Shop and noticed an advertisement for a miniatures painting class by Andrea Depot USA. Now that was interesting! I did a little research and learned some things. Andrea, based out of Spain, specializes in the production of highly detailed miniatures and

acrylic paints for miniatures. Turns out their USA office/warehouse is located in Cedar Park, TX, just under 1.5 hours drive from my location near San Antonio. They were offering a weekend course every month or so to learn how to paint miniatures. The cost of each class included primed subject and accessories, a display base, required paints, brushes, and instruction by renowned miniature painters. Lunches would be provided. All one had to do was sign up, pay, and show up.

Now for me, this was the shiznit of the miniature biznit if I were ever going to learn this. I didn't want to spend hours pouring through YouTube videos followed by more hours of trial and error when I barely had time to build what was already on my bench. I was also intimidated by the unknown and really didn't feel like throwing down moolah on paints and supplies etc., when truly, I was ignorant here and had no idea if I'd like it so much as I liked the idea of it. So I jumped at the opportunity to find out in one weekend.



Andrea's workshop. Esteemed instructors Bob Bethea and Henry Nunez are hovering in the corner ready to pounce.

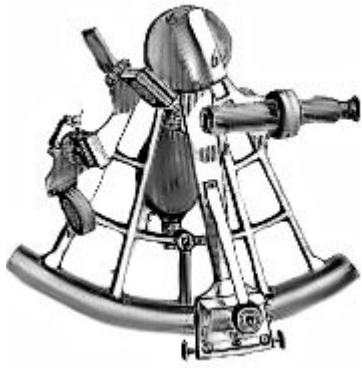

# Feature Story

## A Weekend with Andrea

So the first course opportunity I saw had Napoleon Bonaparte as its subject. I pondered signing up. It was over a month before the course but I was definitely interested, having once written a paper on Napoleon. After a few days I decided to sign up for the course. But it was already closed out—over a month out. Wow.

The next course advertised showed the same subject. By the time I saw that opportunity to sign up, it was closed again. Dang.

My third opportunity to attend a course had as the subject a U.S. Marine, Okinawa 1945. I deployed to Okinawa twice as a Marine so I was going to get into this course one way or another. But it was already again closed! At my wits end I went to the Andrea Depot USA website and called the number. Someone named Alejandra answered and I said “Please get me into the next course!” She obliged and had me first in line for the next course and fortunately the Okinawa Marine was again the subject. I explained to her that the particular weekend wasn’t the best for my work schedule but to sign me up anyway.

When someone unexpectedly dropped from the first Okinawa Marine course she immediately bumped me up. BAM! I was in a course on a weekend with no other commitments. Thank you Alejandra!

My course was 9 to 5 on Saturday, 9 to 3 on Sunday. When I showed up, I just showed up. That’s what they said to do. Don’t bring anything. So I didn’t. The class was limited to six students (which in part explains why the classes fill so quickly!). We were seated in a small room at a square table, two students per side with the two instructors (Bob Bethea

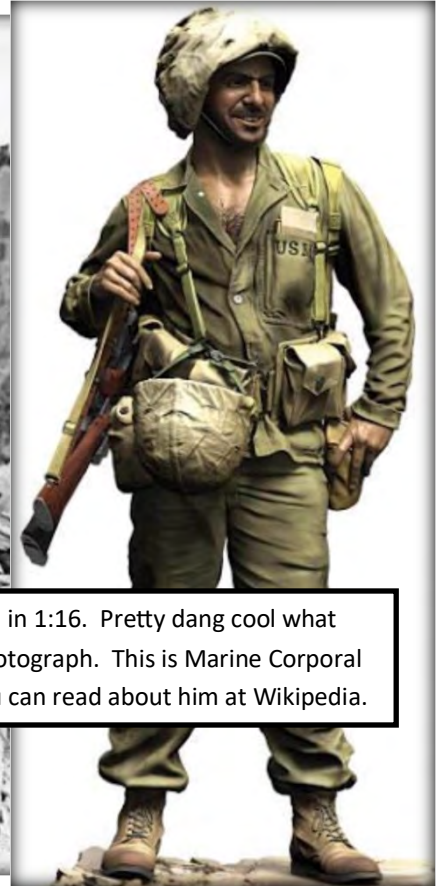

Our subject: U.S. Marine, 1945 in 1:16. Pretty dang cool what Andrea can produce from a photograph. This is Marine Corporal Harry Kizirian on Okinawa. You can read about him at [Wikipedia](#).

and Henry Nunez) on a side. Each station featured individual lamp, a palette with two paint brushes, the figure primed mounted on a base, and accessories (alternate heads with helmet vs. hat) primed and positioned on a block. Required Andrea paints for the subject were available on each side of the table per three students. Alejandra and the instructors greeted us before class and offered donuts.

Henry prepared a detailed and accurate list of the color mixes that we would need for our subject and each student had a copy. Having the color approximations already figured out and all the pieces pre-primed and mounted for painting allowed us to maximize all of our time at the course learning the techniques of painting figures.

So was the course worth the time and money invested? Absolutely. Here’s what I learned:



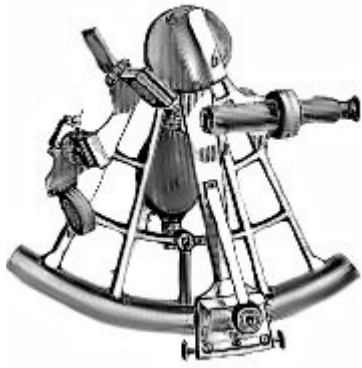

# Feature Story

## A Weekend with Andrea

**I. Acrylics Can Blend.** I entered the course not understanding acrylic (water based) paints very well at all—even though that’s what I primarily use on my aircraft builds. I love acrylics because they dry fast. Don’t we all? But don’t we also hate acrylics because they dry fast? My assumption previously was that they dried too fast to blend. So I’d use acrylics for my primary (base) colors on a build, but use oils when it came time to blend and weather and make details pop. Well apparently all acrylics are not created equal.

In fact the Andrea acrylics that we used dashed many of my preconceptions about acrylics. Each layer of applied Andrea actually blended into the coats beneath—so much so that it seemed you really couldn’t go overboard with shading and lighting. You’d think you over did it and in the next hour or so the color and lighting differences would become more and more subtle, and the shading and color demarcations softer.

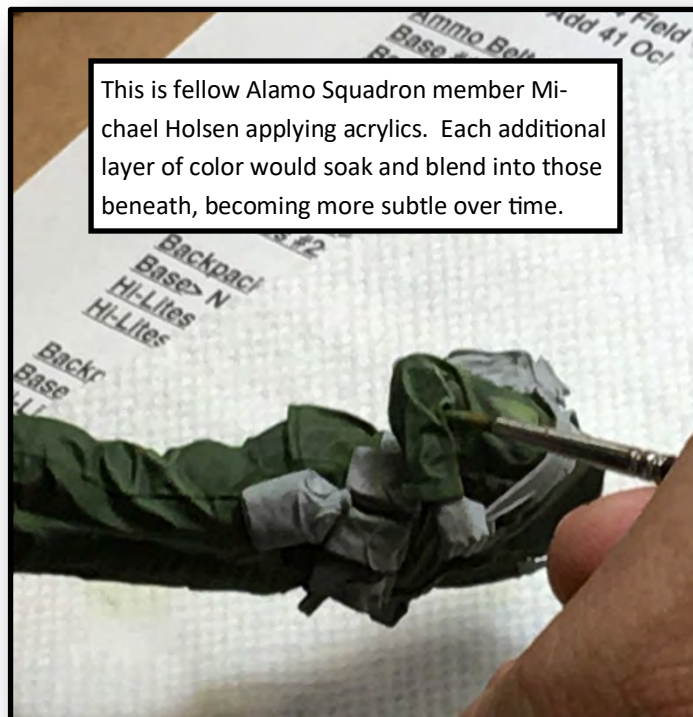

This is fellow Alamo Squadron member Michael Holsen applying acrylics. Each additional layer of color would soak and blend into those beneath, becoming more subtle over time.

Or you’d think you did it perfect and the effect would disappear. Each layer of color and lighting variation continued to soak into the previous layers, brush strokes disappeared, and this process of soaking in and blending and curing continued over-night—long after the “dry to the touch” that occurs a few minutes after application. You could quite literally show up the next day and think someone switched subjects with yours.

These characteristics of Andrea acrylics make the process of painting a miniature very forgiving, so that you can stop worrying about making an irreversible mistake and instead just enjoy the painting. You can go back and forth over an area seemingly ad nauseum until satisfied. It is relaxing and a lot of fun!

**II. Light Comes from Somewhere.** When I build a plane, I don’t think in terms of lighting. I rely on oils and washes to make details pop and they do create a shadow effect. But creating shadows with washes requires no thought about where the light is emanating from or where the shadows should actually be. The wash seeps into the low areas of the details and that’s it. Voila! Shadows in every direction. But this is not realistic. Figure painters on the other hand are consumed with the direction of light and where shadows and light should actually be. Moreover they appreciate that there are variations in the shadows themselves. There are shadows within shadows. There is a darkest part of a shadow—like under the deepest fold in a garment. And the same consideration is given to lighted areas. The outer edge of a clothing fold, in the direction of the light source, will be much lighter. Accurate light variation and placement is the key.

Bob instructed us to place our lamp directly over our primed figure and it became very clear where the

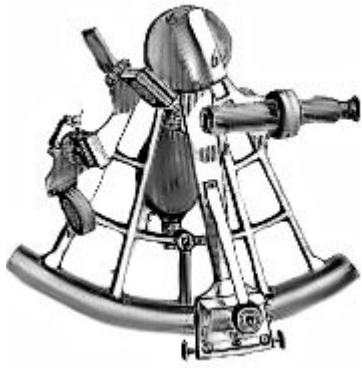

# Feature Story

## A Weekend with Andrea

shadows and light and all their variations should be—that is, if the sun is directly over head!



So how to imitate? We first applied the appropriate base color to the shirt and trousers. We then created shadows and lighted areas using progressively

darkened and lightened mixes of the base color respectively. We used the same approach for the canteens, pack, harness, helmet, face etc.. Always we began with an appropriate base color. As we built up layers of light and shadow the realism and depth of color began to show.

Bob also shared other approaches that we did not use. For example, some individuals prefer to first paint a subject entirely black (this is called black basing) to start with the shadows already in place. Other painters spray the subject with white from the intended direction of the light source and spray black from the opposite end of the subject. This pre-maps the areas of shadow and light before the painter even applies color. With this method the various shades are visible beneath the base colors, acting as a guide of sorts—similar to a “paint by numbers”.

**III. The Wet Palette.** I previously mentioned that one of the difficulties in using acrylics is that they dry fast. This is particularly challenging when mixing/ applying paints from a traditional (dry) palette. Prior to attending the course I was only familiar with the dry palette, and almost the entirety of the first day I fought a dry palette. The second day I showed up with a wet palette, and it drastically and positively changed my experience.

Understand there’s nothing wrong with a dry palette. Henry prefers it. His results are amazing. But for someone new to miniatures like me, I think the wet palette is a good way to go. So what exactly is a wet palette, and why do I favor it?

A wet palette is created by placing a parchment paper on top of a layer that is saturated with water (the saturated layer can be a thin layer of sponge or just a stack of folded paper towel for example). The point



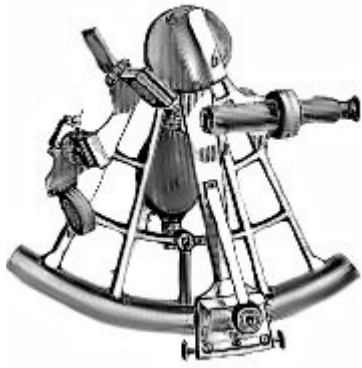

# Feature Story

## A Weekend with Andrea

here is that the water in the saturated layer seeps upward through the parchment just enough to keep the paint on the other side moist—the paint is too thick to seep downward. And so the acrylic paint on your parchment paper stays moist but maintains its integrity. If you place your wet palette inside Tupperware, your palette can last several days, and weeks if sealed in the fridge.

The advantage of a wet palette is that you can continue going back to your base colors as you adjust for darker and lighter applications. And they're always there. They're still moist and as previously mixed. You don't have to re-create the base colors over and over again as you move back and forth



Towards the end of the first day I experienced the wonders of the wet palette for the first time. Just a foam plate with soaked paper towel, single sheet of parchment paper on top.



Michael came to the course already armed with a wet palette. His was fancier, featuring soaked sponge and a tupperware container with built-in water basin!

across the subject from one area to another according to your liking and from one moment to the next. The wet palette, for me, was liberating. I could focus on painting rather than on keeping paint.

I mentioned that Henry prefers a dry palette but he is so very good. He can mix colors quickly and doesn't make a lot of mistakes like someone new to miniatures. I don't think he has to go back to his base colors much as he progresses through darker and lighter shades. I will also say that I believe one advantage of the dry palette however is that it forces more



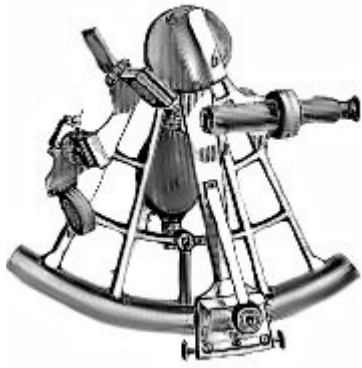

# Feature Story

## A Weekend with Andrea

variation in color as you have to mix and re-mix colors. Perhaps an unintended result is more breadth of color, less risk of monotone. This is just a theory of mine.

**IV. There's No Right Way.** For me the final big takeaway from the course is that there really is no single right way—as long as one understands color and where the lighting and shadows should be. Bob likes a wet palette. Henry likes a dry palette. Bob prefers to paint the face and eyes first. Henry likes to paint those last. Bob is more aggressive in his application of lighting and shadows, Henry more subtle. Both achieve fantastic results. It was great having two very different yet complimentary instructors at the helm, using the same mixes on the same subject with very different results—yet both results outstanding!

In sum, I highly recommend this course. Understand that my perspective is one of someone completely new to miniature painting, and I strongly encourage anyone interested to actually take the course and/or ask Bob and Henry for validation of my observations. To my knowledge three other individuals in our club have taken this course to date—Michael Holsen, Charles Stone, and Dick Montgomery. Each have shared strongly favorable comments of the course as well.



This is as far as I got. For my first time painting a miniature I was very pleased with the results and hope to add a figure to one of my builds in the near future.

A final benefit of attending the course is that Alejandra opens up the warehouse for viewing and purchases. This is a great opportunity to see all of the products that Andrea Depot has to offer. I particularly enjoyed looking at all the available miniatures!

-ES



# Feature Story

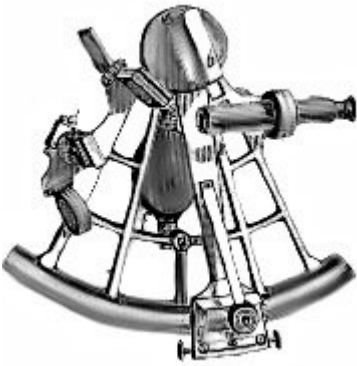

## Packing For The Nats

Story and Photos by Rob Booth

IPMS# 37548

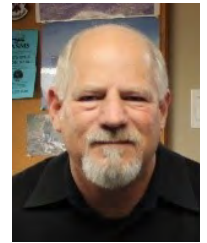

It was that time of year again and the IPMS National Convention was upon us in August. I spent a couple hours planning the best way to transport my entries from my display case to the contest tables, with a minimum opportunity for any catastrophic damage to them. As an airplane guy, my packing method is tailored towards that genre, but most of my system is adaptable to other subjects. It's really just a contest specific adaptation of the same container that I use when I travel by car or truck to our regional contests.



First, I am still a working stiff, so limiting my available vacation time means I have to travel by commercial air service (UGH!) to the NATS convention city. As if airline travel these days isn't enough of a pain, try coming up with a packing system that you would entrust to airline baggage handlers to get your prized entries to another city across the country! In my opinion, that's just not an economic feasibility!

So, my first task was to come up with a light weight container that would fit within the overhead luggage bin of most of today's commercial airliners. That actually involves planning a flight itinerary on an airline that will use Boeing 737 or larger aircraft for all legs. The smaller commuter aircraft just don't have enough overhead room to allow for my system, and the checked baggage system is NOT an option!

I have obtained a couple of plastic storage bins over the years that come close to the 45 total inch carry on size limitations of most airlines. I use these same containers for local contests with a piece of scrap shag carpet in the bottom of it to keep my planes from moving around. The length actually exceeds the strict dimensioning by a couple of inches, but I've never been kicked off of a flight for it. Usually, if a flight attendant questions whether my container will fit in the overhead compartment, I just open the lid for closer inspection by whomever, and the "wow" factor takes over. Then, you get "Captain, you HAVE to see this!", and blah, blah, blah. But I digress ...

I bought a couple sheets of inexpensive Styrofoam sheet wall insulation a few years ago (less than \$15 for a 4'X8'X3/4" sheet) to experiment with for just this purpose. My plan was to come up with a system that would allow me to maximize the number of models I could place in the space available, and then "lock and fix" the position of each model in place to prevent any movement in any direction. I traced out the inside dimension and pattern for each of my bins, and cut out a Styrofoam "base" that would fit in the bottom of each .



# Feature Story

## Packing For The Nats

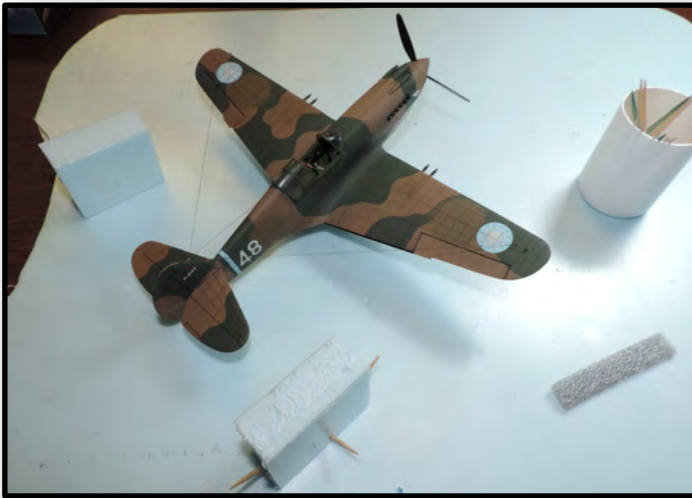
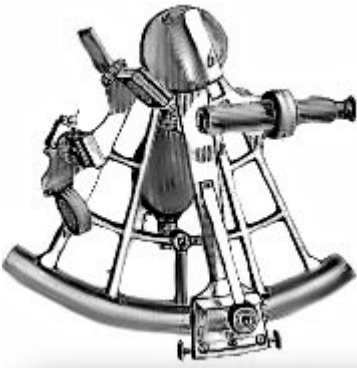

Starting with my usual carpet base, I then experiment with the placement of each model to maximize the space available to fit the number of entries I'm dealing with. My typical haul would include 6-10 subjects in 1/72 and 1/48 scale. When I'm satisfied with a layout that accommodates all my models without touching each other to avoid scratches and scrapes, I take a digital photo for reference, and go to work with the Styrofoam.

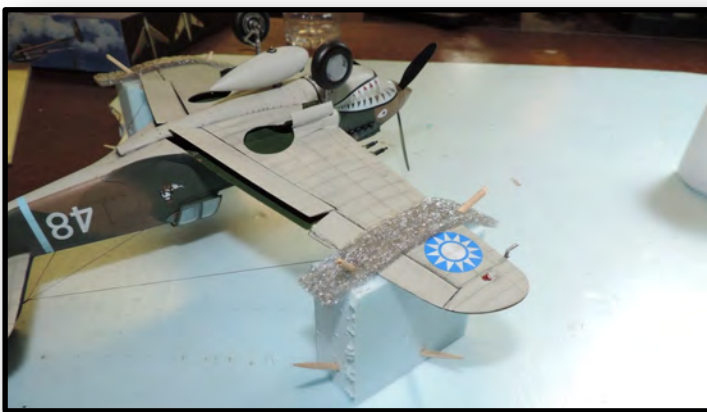

I begin by cutting a couple of identical pieces of foam that will support the wings of each aircraft in an inverted position. The pieces of foam must allow the aircraft to clear any antenna or open canopies from the foam base, but not so tall that it puts the

landing gear too close to the bin lid, as the lid will "give" from above. After cutting the appropriate blocks, I begin placing each model to match the layout I came up with, one at a time. I attach the Styrofoam blocks to the base with toothpicks pushed through the blocks and into the base sheet at an angle to fix them in place. Each aircraft is then



placed, inverted, on the top of the blocks on their wings, and affixed with thin foam "straps" held in place by more toothpicks. This system effectively "locks" each model in its respective space, and prevents any shifting or movement with the exception of an all out drop kick or free-fall of the container. A couple of foam "columns" here and there, prevent the possibility of a jolt or bounce causing the entire sheet to raise up and collide with the plastic lid, damaging fragile landing gear, ordnance, etc.

This system has served me well, travelling to five or six National Contests without any major catastrophes to my entries. In fact, I have inflicted way more damage removing models from my display case or placing them on contest tables, than I have suffered as a result of "travel" damage. —RB



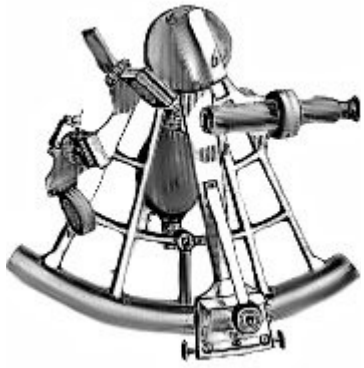

# Show Report:

## 13th Annual HAMS Model Car Show & Contest

**O**n July 20th Alamo Squadron members and avid automotive modelers John Kress and Keith Rule travelled to Houston to attend Houston Automotive Modelers' Society's 13th Annual Model Car Show and Contest. Here is a quick snippet of how they fared:

Member	Class/Category	Award	Entry Description
Keith Rule	Factory-Showroom	3rd	'52 Hudson Hornet
	Commercial Vehicles	2nd	International Lonestar
	Drag Racing	2nd	'66 Chevy Nova Super
	Box Stock	2nd	Street
	Str Machine	3rd	'53 Ford Crestliner
	'40&Later	2nd	'65 Shelby Mustang
	Lowriders	2nd	'48 Caddy Eldorado
	Foreign & Exotic	3rd	Bugatti Royal Napoleon
	Str Machine '48	3rd	'33 Willys Coupe
John Kress	Box Stock	3rd	'70 Road Runner



'48 Caddy Eldorado

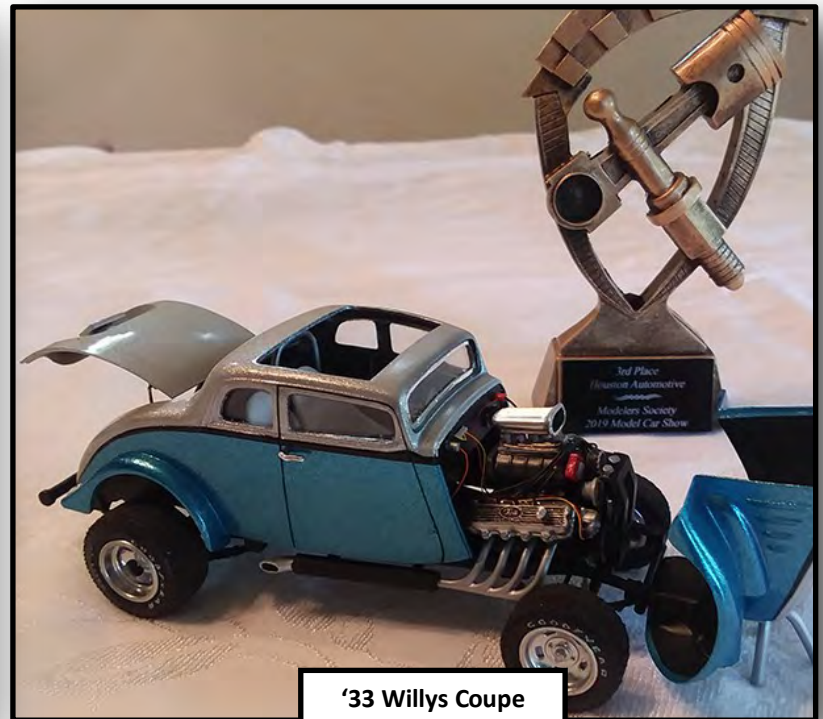

'33 Willys Coupe

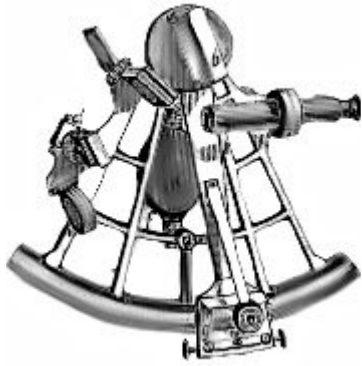

# Upcoming Events

IPMS Region 6

**Next Meeting: Thursday, Aug 1st, 2019 at 7:00PM**

**Location: Northside Ford of San Antonio**

**Aug 7– 10, 2019**

IPMS National Convention  
Chattanooga Convention Center  
Chattanooga, TN.

<http://www.ipmsnationals.com/>



**Aug 18, 2019**

Bassett Place and Show Display  
Gateway West M-36, El Paso, TX, 79925 El Paso, Tx  
POC- [bagpiejm@aol.com](mailto:bagpiejm@aol.com)



**Sept 14, 2019**

SuperCon 2019 Hosted by Ft. Worth Scale Modelers  
Bob Duncan Community Center  
2800 S. Center St. Vandergriff Park  
Arlington, Texas

<http://fortworthscalemodelers.org/SuperCon.html>



**Sept 28, 2019**

2019 Sprue Doo Hosted by Central Arkansas Scale Modelers  
(See club website for updated information on location)  
North Little Rock, Arkansas

<http://www.casmodels.org/>



**Oct 19, 2019**

Cajun ModelFest 33 Hosted by Baton Rouge Scale Modelers  
LSU Ag Center's Minifarm Bldg.

<http://www.brscamodelers.com/>



**Jan 26, 2020**

CALMEX XXXIV Hosted by IPMS SWAMP  
Lake Charles Convention Center,  
900 Lakeshore Dr. Lake Charles, LA

[www.ipmsswamp.com](http://www.ipmsswamp.com)





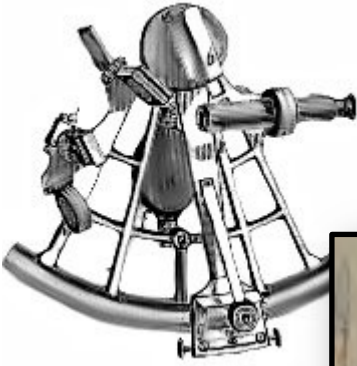

# About Alamo Squadron

## Executive Board 2019-2020



**President**  
**Craig Gregory**  
IPMS #49320



**Vice President:**  
**Len Pilhofer**  
IPMS #49932



**Treasurer:**  
**Chris Settle**

**IPMS/USA Alamo Squadron** was founded on November 17<sup>th</sup>, 1977 in San Antonio, Texas, for the enjoyment of building scale models and the camaraderie of the members. It is a hobby-centered social organization which, at its core, is focused on scale modeling of all kinds. It is an excellent source of information for those who wish to enhance their modeling skills and improve their modeling techniques, and is open and inviting to visitors and guests. Dues are \$24.00 a year, due to the treasurer on September 1st of each year.

Alamo Squadron has been hosting ModelFiesta since 1981. Locations have included the Wonderland Mall, a Holiday Inn, the Seven Oaks Motel & Convention Center, the Live Oak Civic Center and the new location in 2013, the San Antonio Event Center.



QR Code for our Web Site  
Scan it with your cell phone's QR software to get to our web site!



QR Code for our Facebook Page  
Scan it with your cell phone's QR software to get to our home on FB

[www.alamosquadron.com](http://www.alamosquadron.com)



# Final Words ...

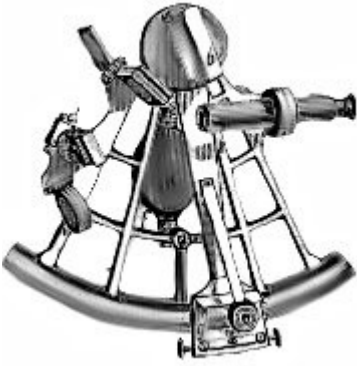

Alamo Squadron's newsletter, "The Navigator", is published monthly by IPMS/USA Alamo Squadron of San Antonio, Texas for the enjoyment of the members of Alamo Squadron and its friends around the world. Articles, reviews, news items, and other hobby-related contributions are very welcome. Send text file, photos, and web sites as well as feedback to our editor, Len

Pilhofer: [pilhofer@hotmail.com](mailto:pilhofer@hotmail.com)

<http://www.ipmsusa.org/>

IPMS/USA MEMBERSHIP FORM			
IPMS No.:	Name:		
	First	Middle	Last
Address: _____			
City: _____ State: _____ Zip: _____			
Phone: _____		E-mail: _____	
Signature (required by PG): _____			
Type of Membership <input type="checkbox"/> Adult, 1 Year: \$30 <input type="checkbox"/> Adult, 2 Years: \$58 <input type="checkbox"/> Adult, 3 Years: \$86			
<input type="checkbox"/> Junior (Under 18 Years) \$17 <input type="checkbox"/> Family, 1 Year: \$35 (Adult + \$5, One Set Journals) How Many Cards? _____			
<input type="checkbox"/> Canada & Mexico: \$35 <input type="checkbox"/> Other / Foreign: \$38 (surface) Checks must be drawn on a US bank or international money order			
Payment Method: <input type="checkbox"/> Check <input type="checkbox"/> Money Order			
Chapter Affiliation, (if any): _____			
If Recommended by an IPMS Member, Please List His / Her Name and Member Number: _____			
Name: _____		IPMS No.: _____	
<b>IPMS/USA</b>		PO Box 56023	
Join or Renew Online at: <a href="http://www.ipmsusa.org">www.ipmsusa.org</a>		St. Petersburg, FL 33732-6023	



## Support your Local Hobby Shops!

For models, paints, books, decals, tools and more!



Email: [dibbleshobbies@gmail.com](mailto:dibbleshobbies@gmail.com)

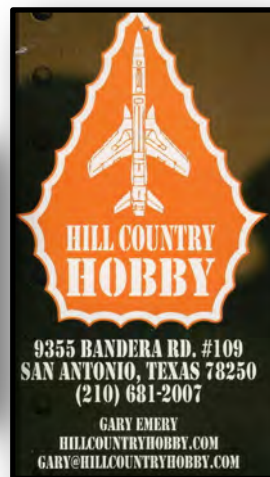

<https://www.hillcountryhobby.com>



<https://www.hobbytown.com/san-antonio-tx/l108>